

Installation instructions

2311901 2311901C

Operating conditions

Recommended flow temperature $\leq 65^{\circ}\text{C}$
 Maximum flow temperature momentary $\leq 90^{\circ}\text{C}$
 Minimum flow pressure 1 bar
 Maximum flow pressure 5 bar
 Recommended operating pressure 3 bar
 Test pressure 16 bar

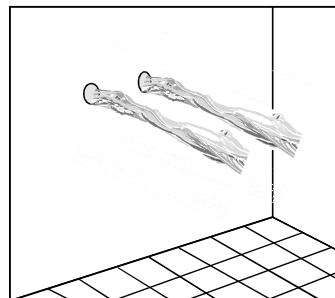

Notes

Before installing the valves, clean the water pipe thoroughly to avoid dirt and deposits

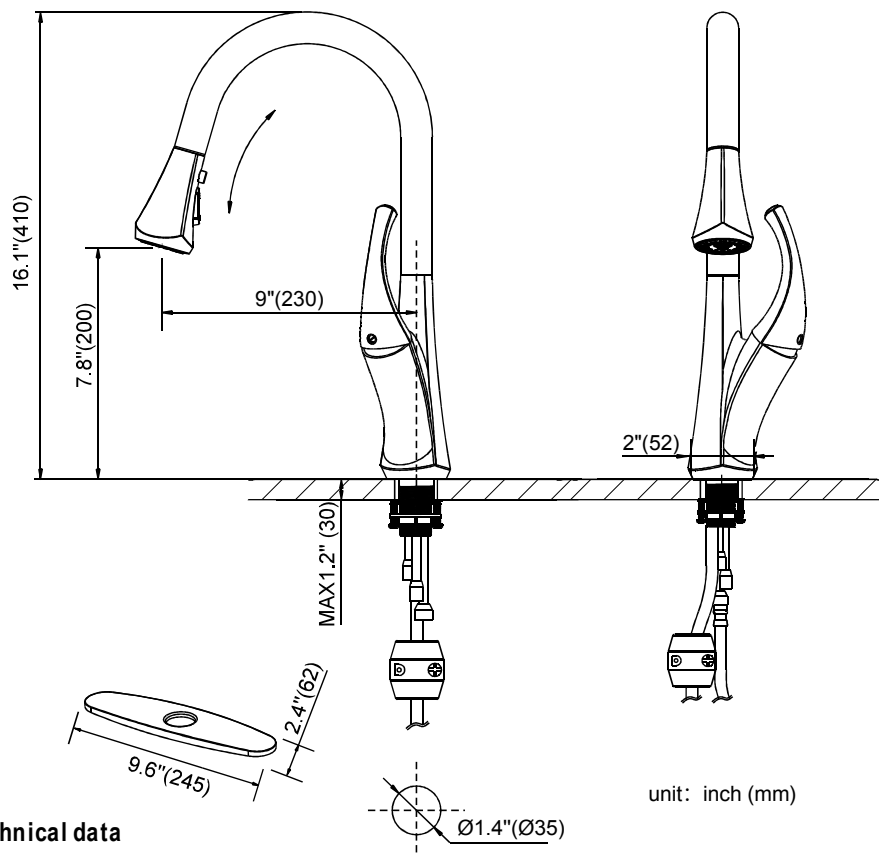

Technical data

1. Screw flexible hoses (14) under the body (1)
2. Attach the O-ring (3) to the base of faucet body
3. Insert the plate (4) and washer (5) under the body
4. Insert washer (7) and SS304 washer (8) through threaded rod (2)
5. Screw hexagonal lock nut (9) on to threaded rod (2) and tighten.
6. Screw then ut (9) with screws (10) to fix the faucet body (1)
7. Connect pull-out hose (12) with washer (11) to inlet connection (6)
8. Attach weight (13) to pull-out hose (12)

